

Article number: 203180M24150B1T
 Description: E+G levelling foot
 GN 31-80-M24-150-B1-T
 Note: T Without nut, Wrench flat at the bottom

Measures

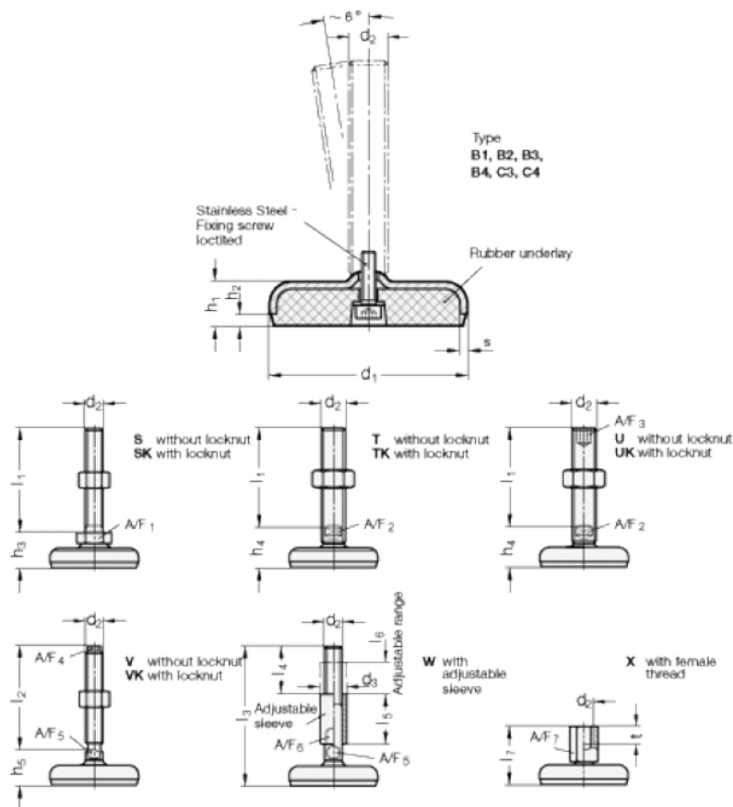

A/F2	= 19
d1	= 80
d2	= 24
h1	= 18
h2	= 5
h4 +4.0/0	= 36
l2	= 150
s	= 3